

TNAR™



LEGO®

The LEGO logo is displayed in its characteristic red square with white and yellow text.



4



14

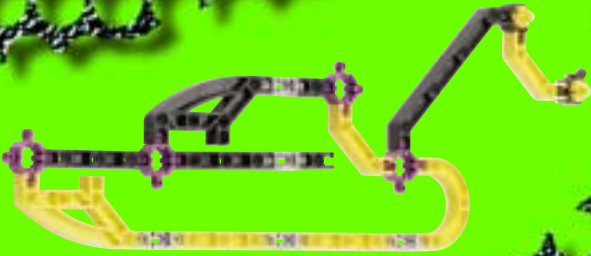

8



20

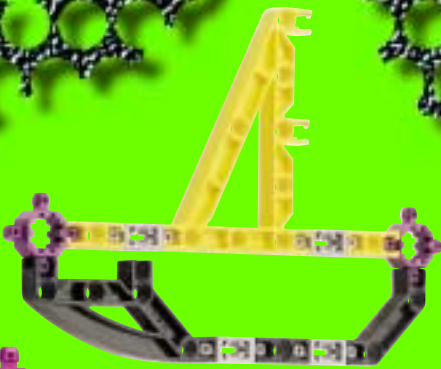

9



28



12



34



2

2



1

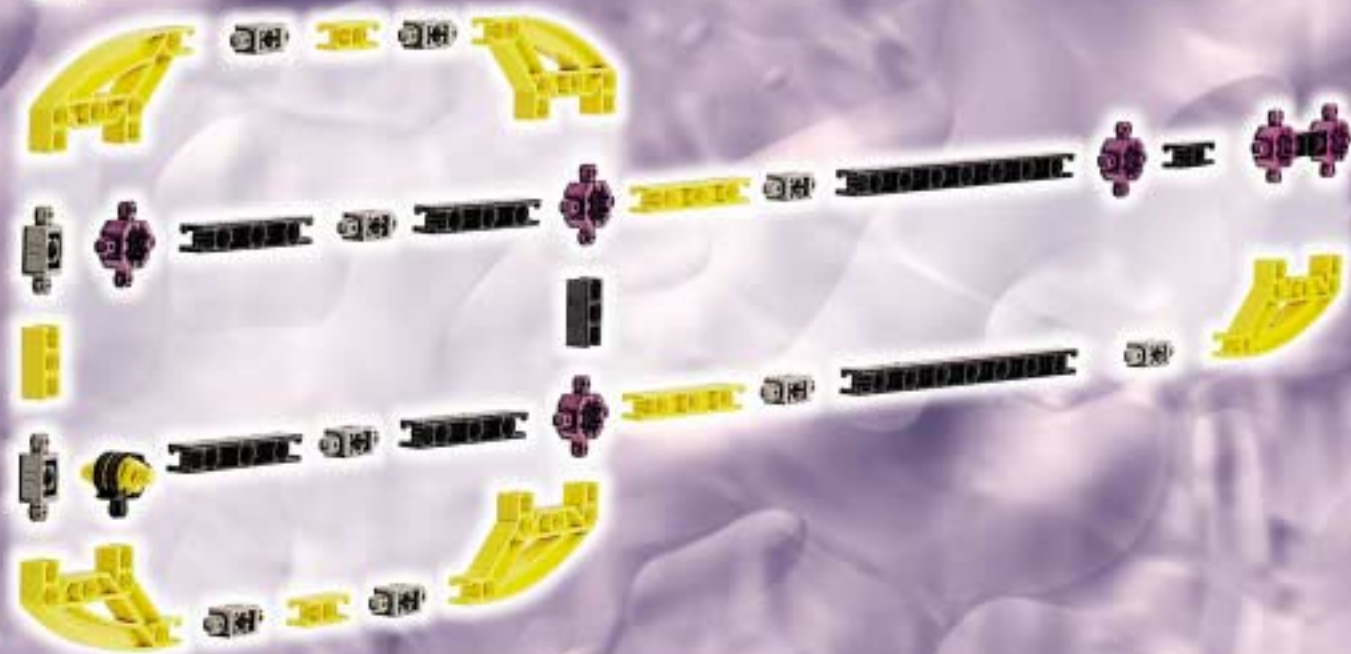

2

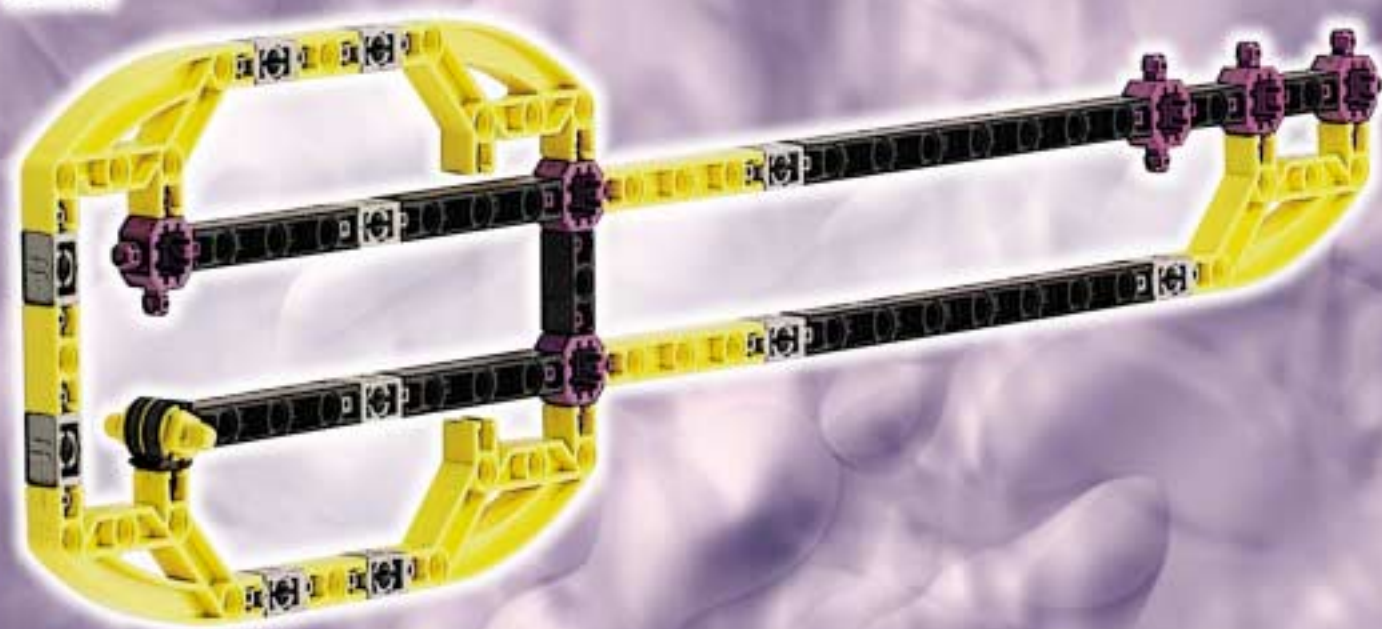

3



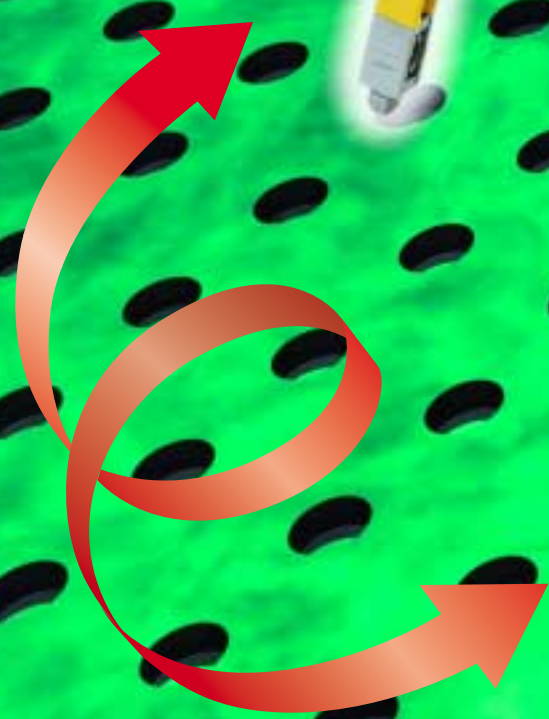

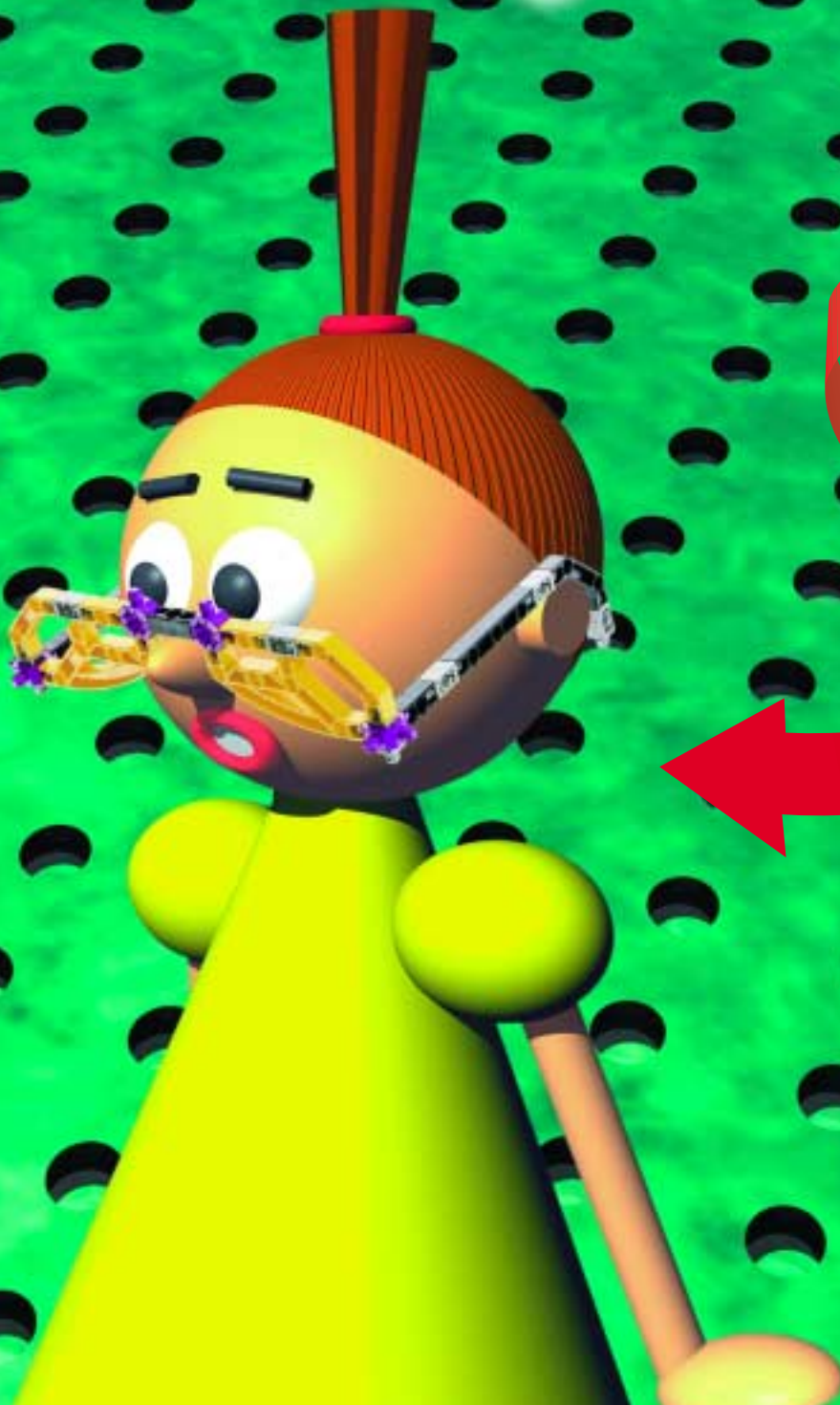
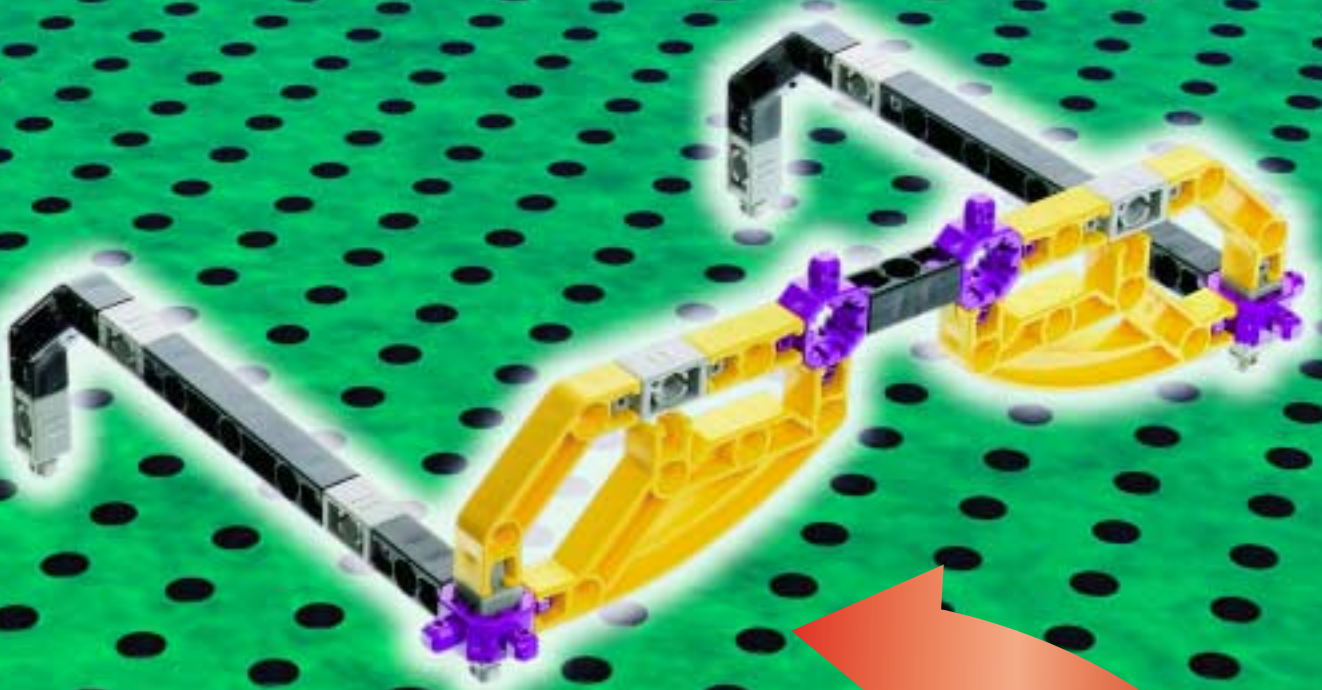

1



2

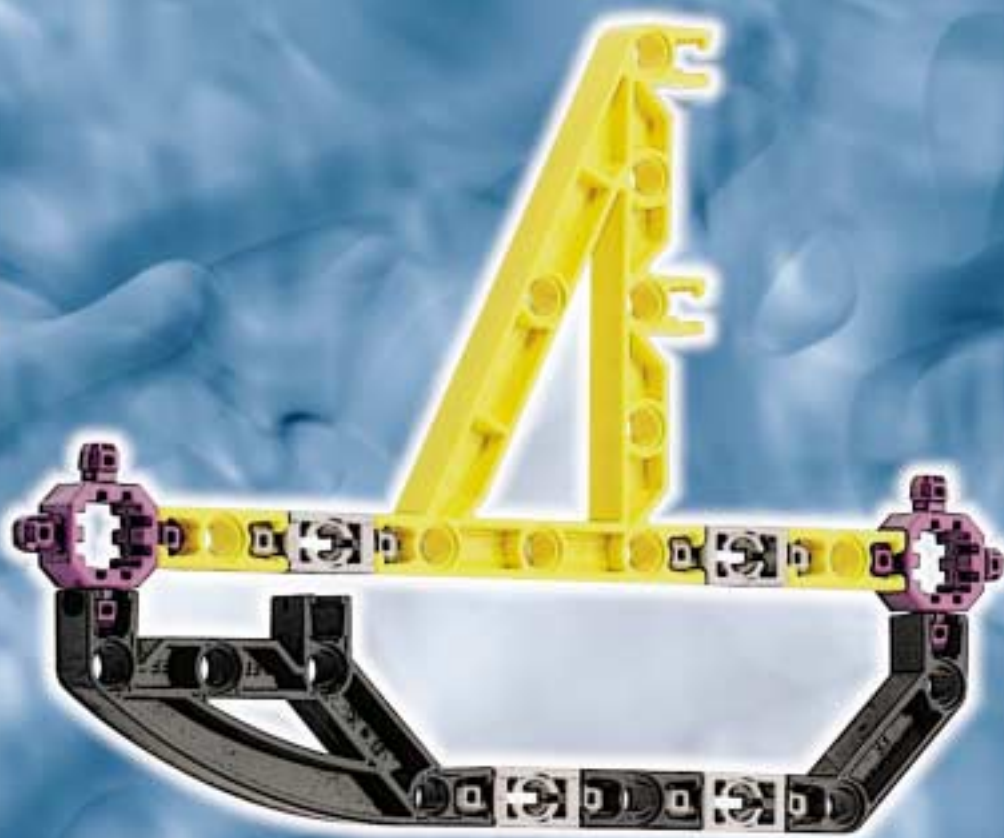







TRANS  FORM



1



3



2



4

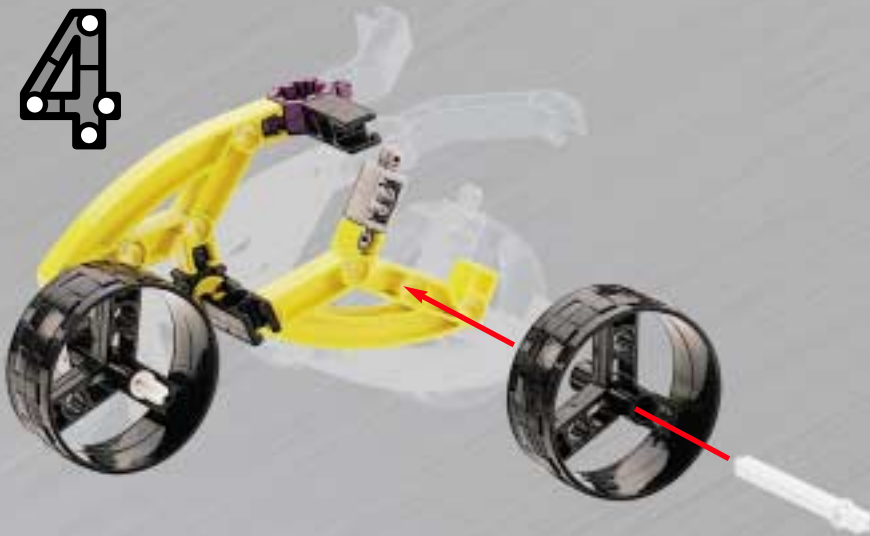

5



6



1



2



3



TRANS FORM



2



3



4

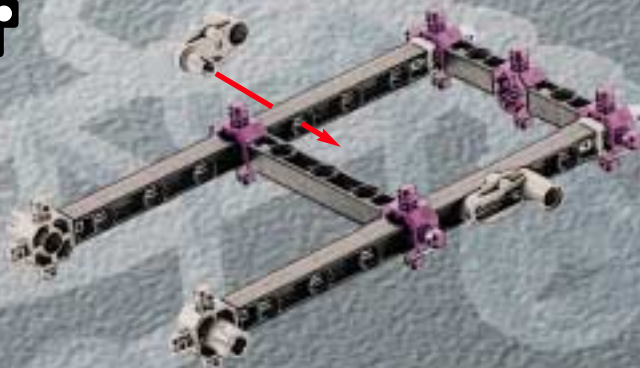

5



6



7





10



11



12



13



14



15



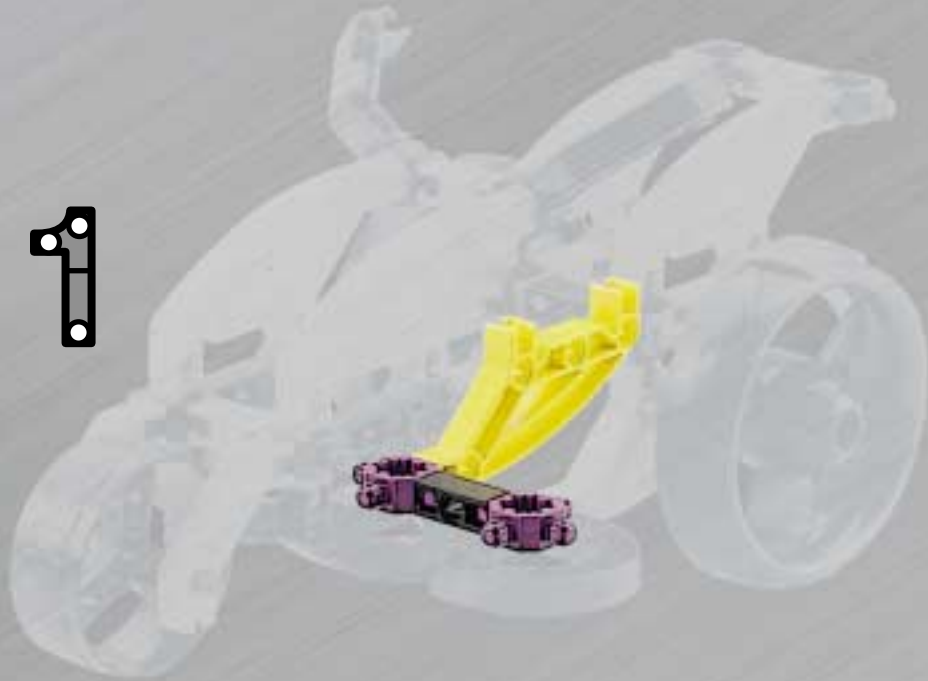

2



3



4

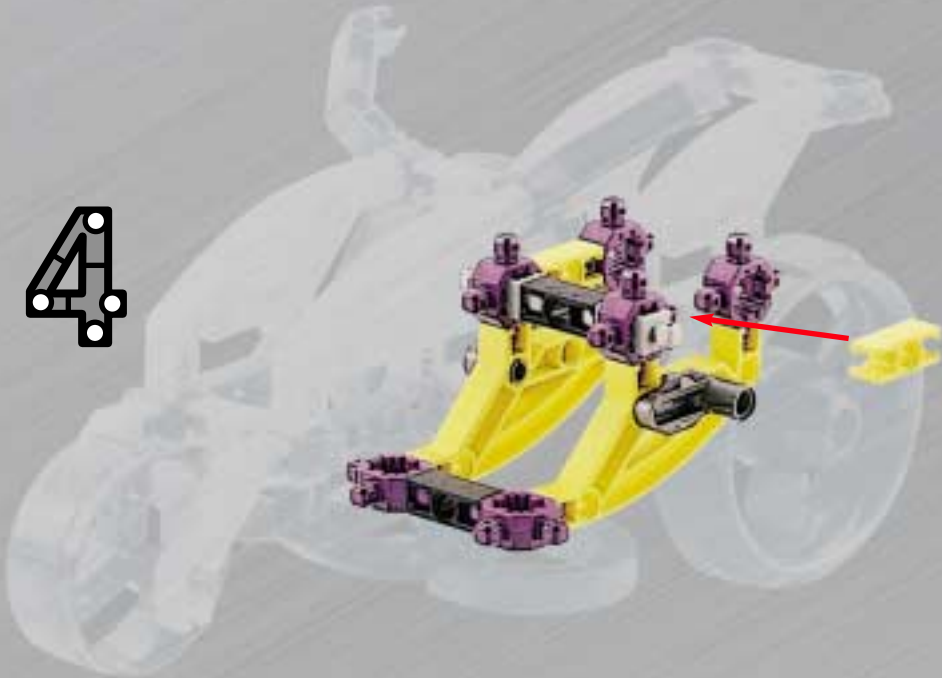

5



6



7



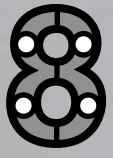

10

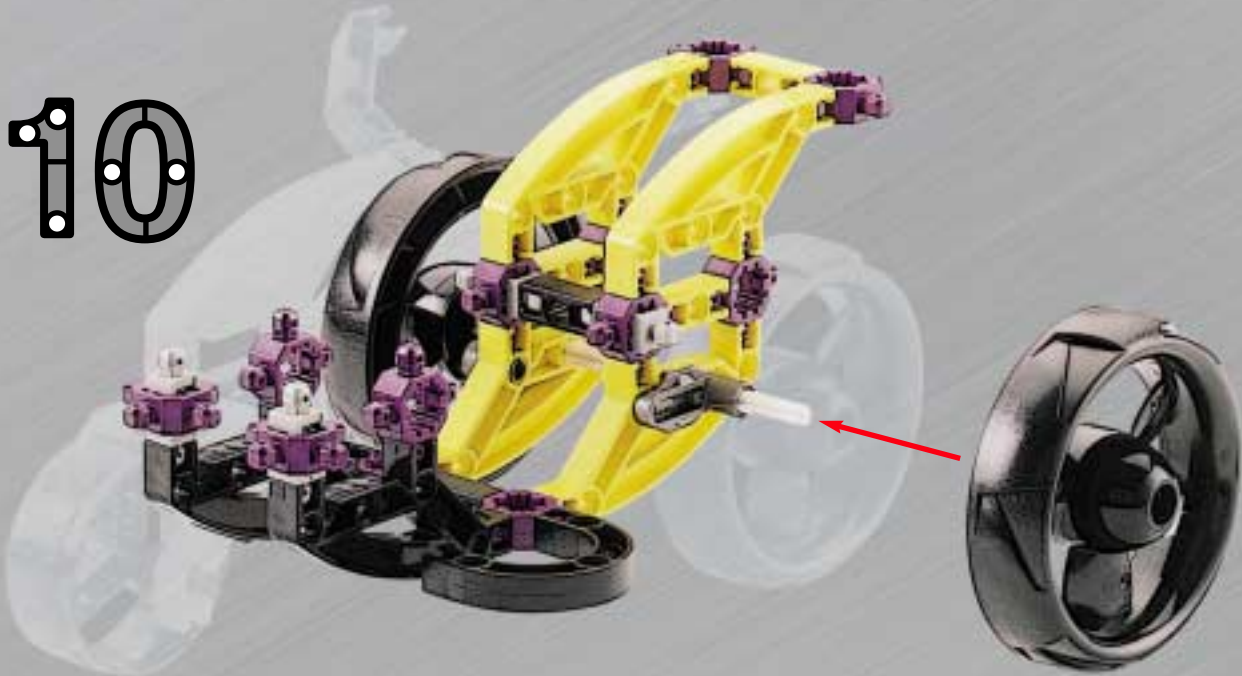

11



12



13



14



15

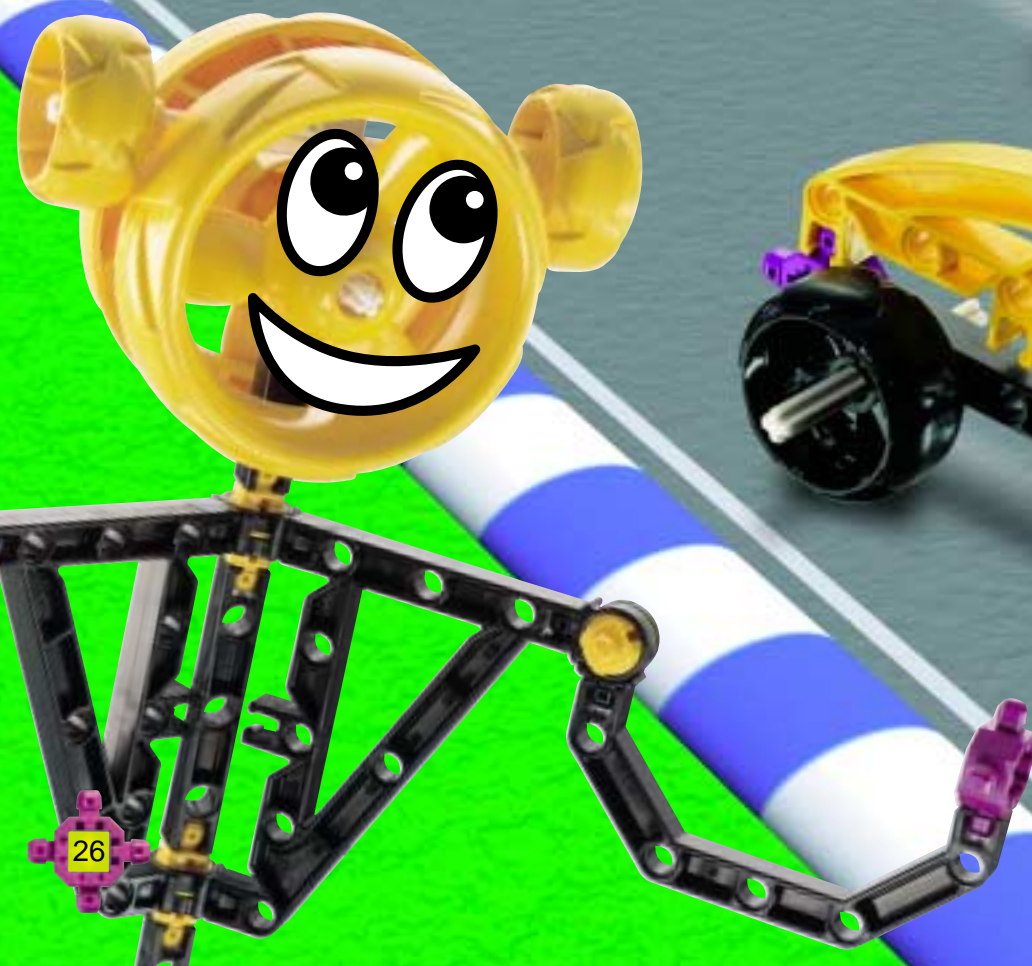

TIME
15:34
FUEL

A digital display with a black background and yellow text. The word "TIME" is at the top, followed by "15:34" in a large font. Below that is the word "FUEL" and a horizontal fuel gauge with a red bar on the left and a white bar on the right.





TRANS  FORM



2



3



4



5



6



7





3



4



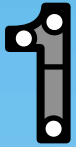

2



3

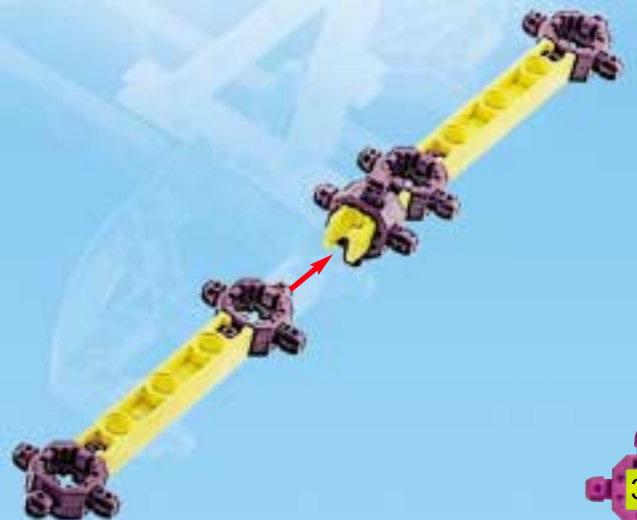

4



5



6



7



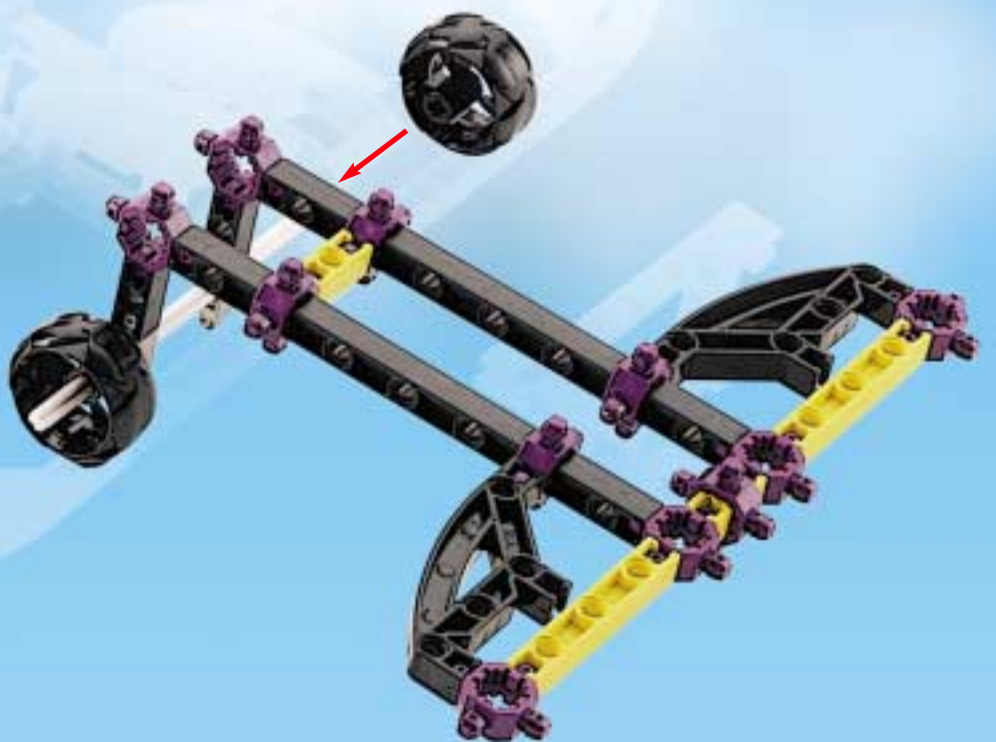

10



11



12



13



14



15



16



17



18





2



3



4



5



6



7



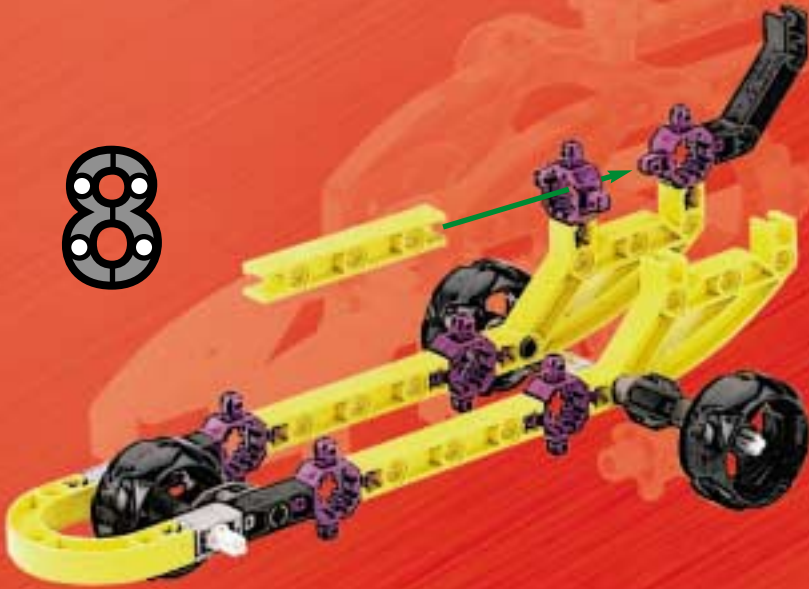

10



11



12



13

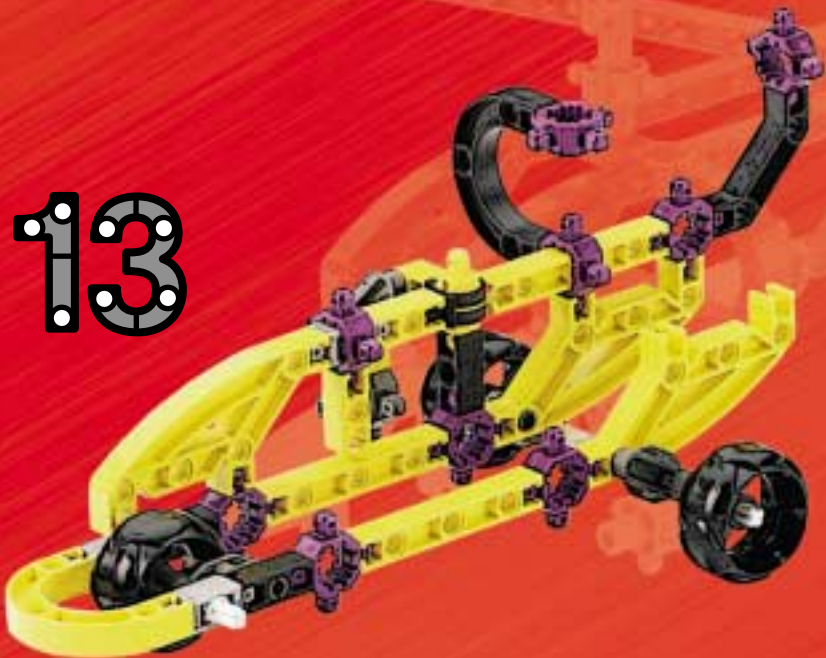

14



15



16



17



18



19



20



21



22



23



24



25





26



27







2



3



4



5







10



11





2



3



4



5



6



7





10



11



12



13



14



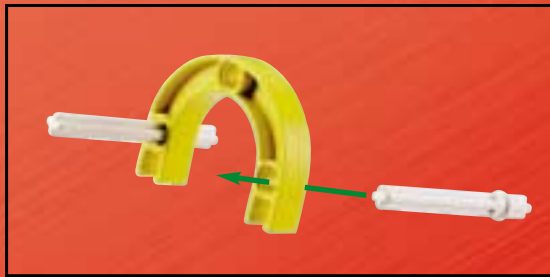

15

16









1

2



3



4



5



6



7





10



11



12



13



14



15









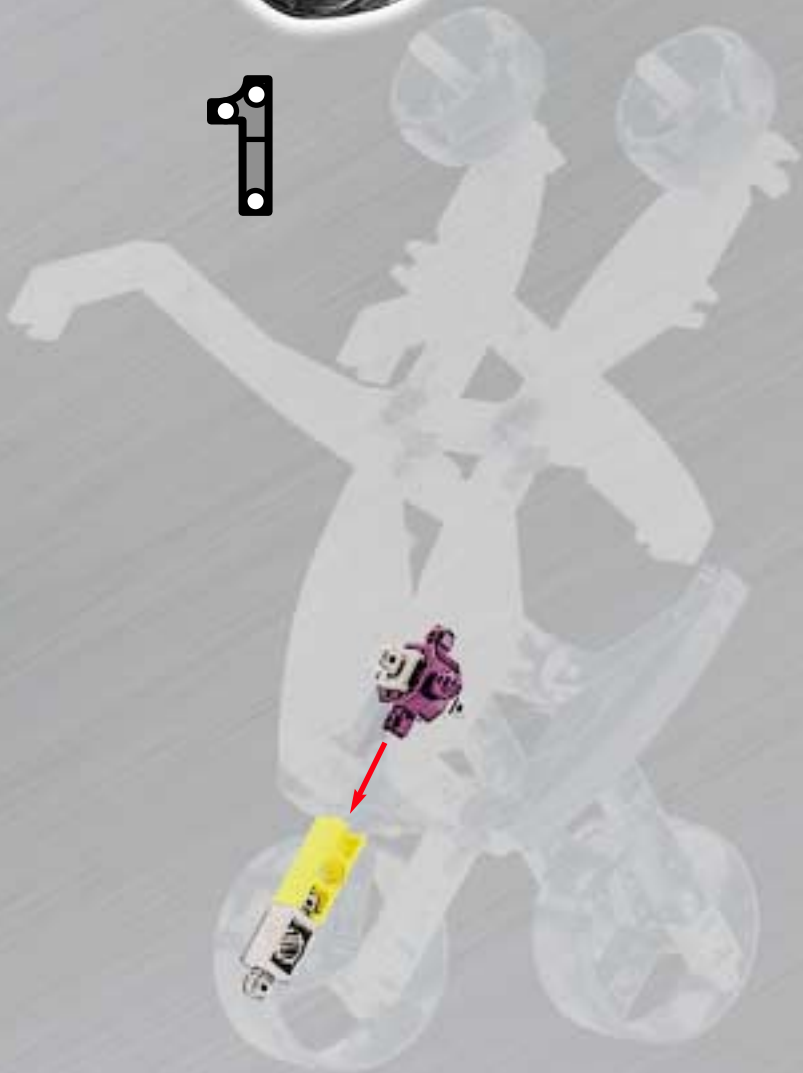

2

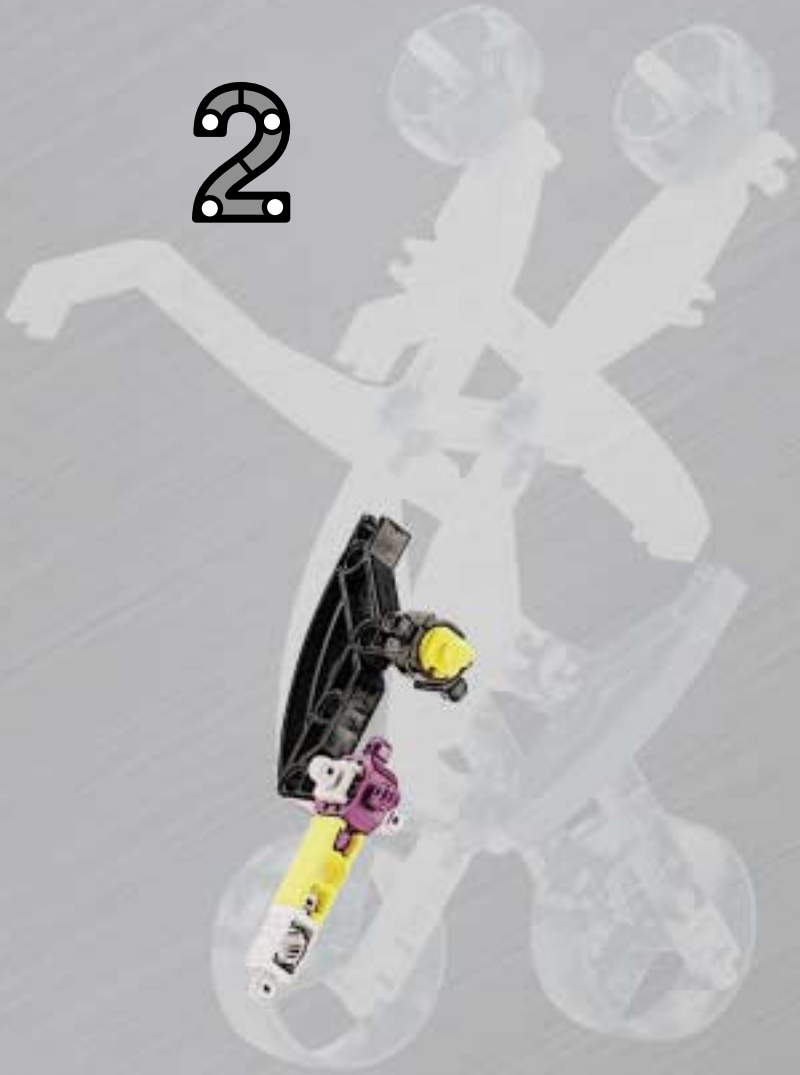

3



4



5



6

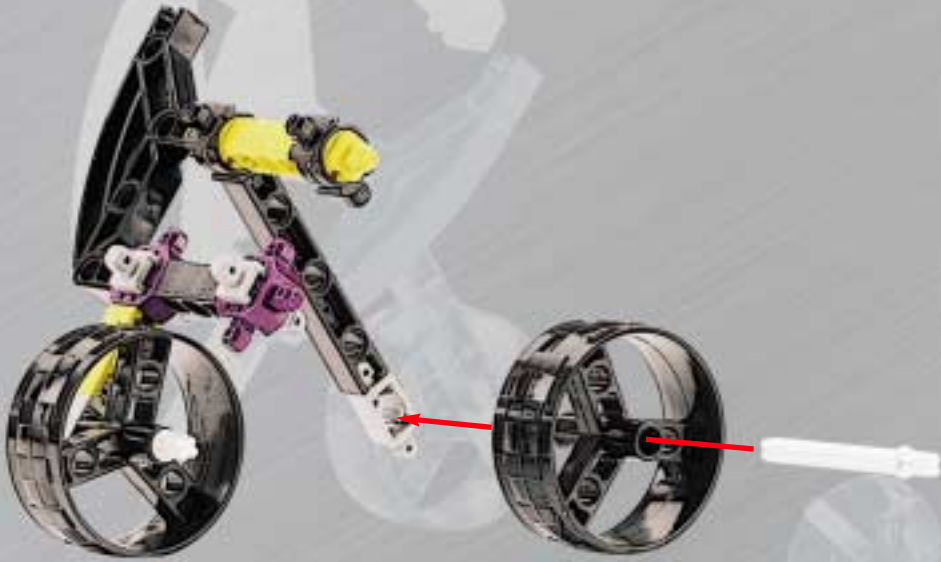

7



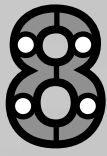

10



11



12



13



14



TRANS  FORM



2

3



4









3



4



5



6



9



10



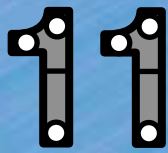
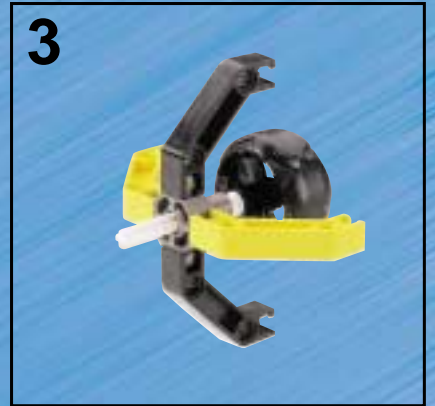
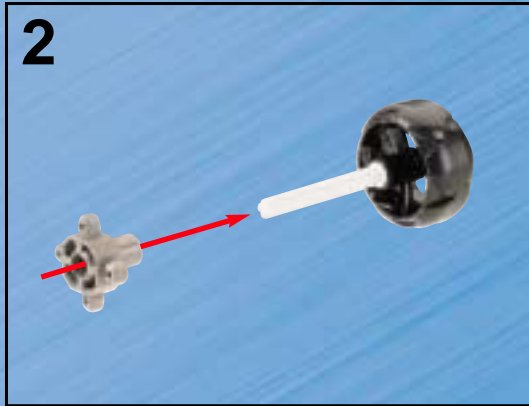
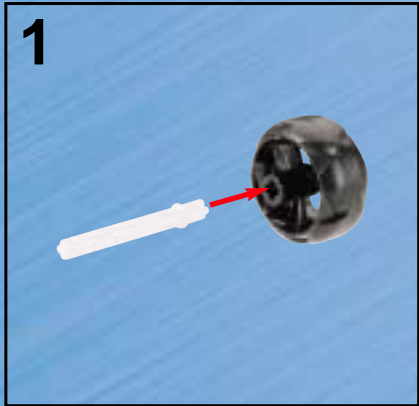

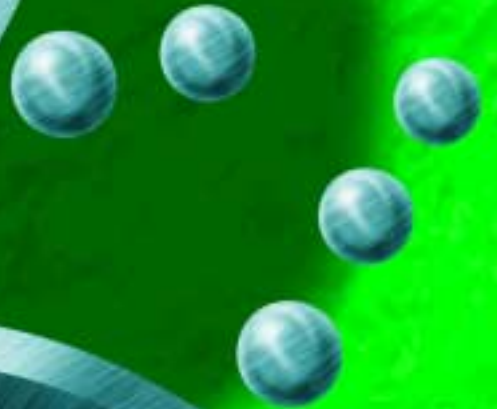

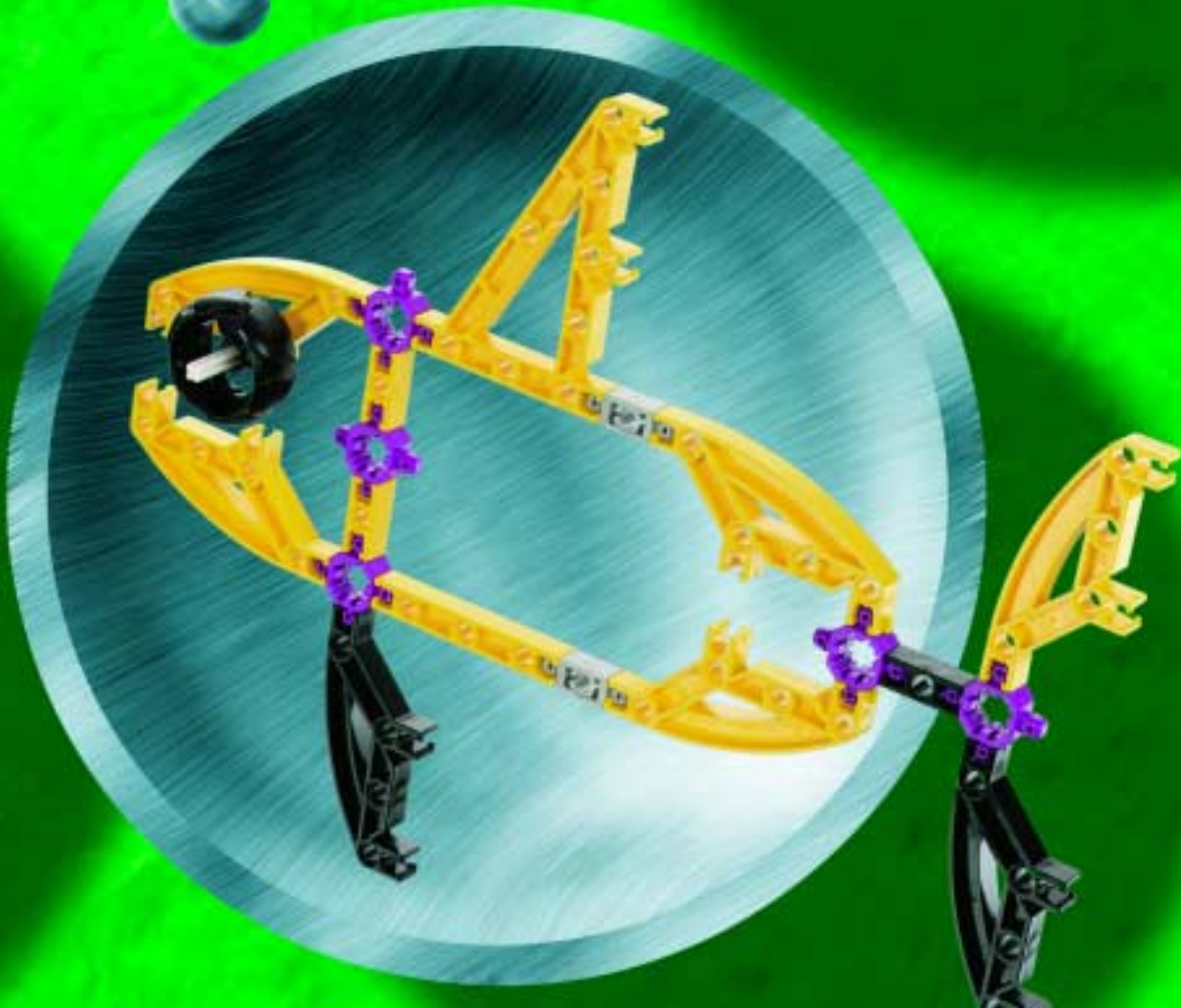



2



3



4



5



6



7





10









2





3



4



5



6



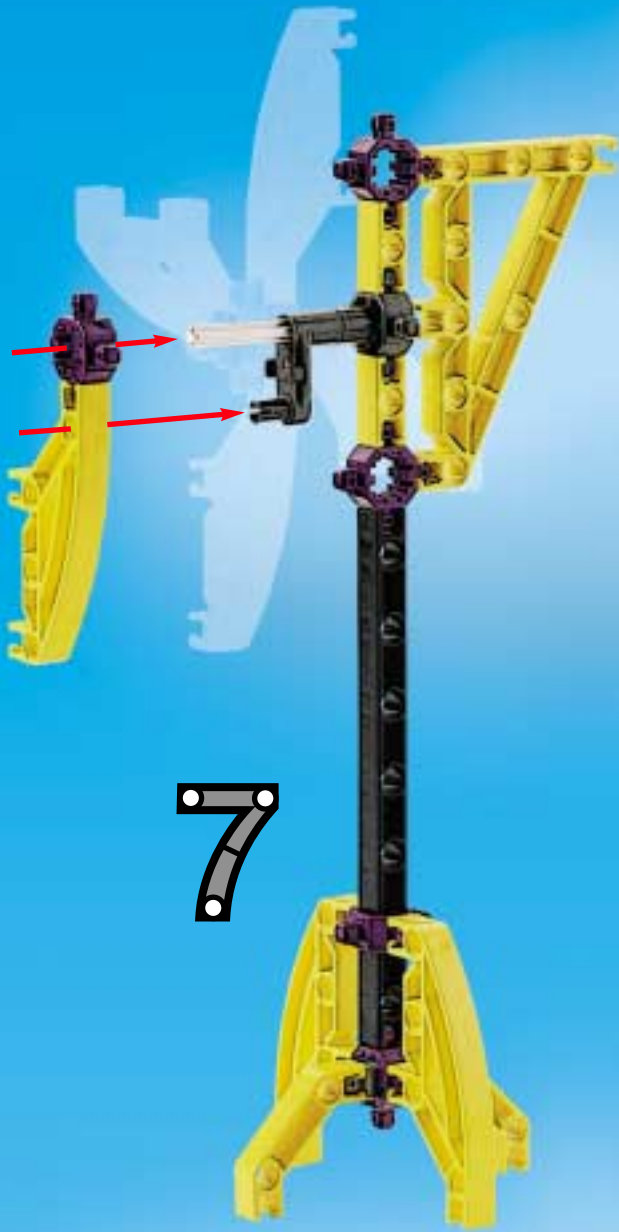

7





4129090

© LEGO is a registered trademark

© 1999 LEGO Group.

<http://www.LEGO.com>

